

GP Series



Operating Instructions



Rev. F2 05/2017
54201



FLUKE COMPANY
Everett, WA U.S.A.

GPRSF

P/N 3363852

S/N 
17920001



Made in China *Manufactured: Oct, 2011*

Contacts

Fluke Process Instruments

Fluke Process Instruments North America

Santa Cruz, CA USA

Tel: +1 800 227 8074 (USA and Canada, only)
+1 831 458 3900

solutions@flukeprocessinstruments.com

Fluke Process Instruments Europe

Berlin, Germany

Tel: +49 30 478 0080

info@flukeprocessinstruments.de

Fluke Process Instruments China

Beijing, China

Tel: +86 10 6438 4691

info@flukeprocessinstruments.cn

Worldwide Service

Fluke Process Instruments offers services, including repair and calibration. For more information, contact your local office.

www.flukeprocessinstruments.com

WARRANTY

The manufacturer warrants this instrument to be free from defects in material and workmanship under normal use and service for the period of two years from date of purchase. This warranty extends only to the original purchaser. This warranty shall not apply to fuses, batteries, or any product that has been subject to misuse, neglect, accident, or abnormal conditions of operation.

In the event of failure of a product covered by this warranty, the manufacturer will repair the instrument when it is returned by the purchaser, freight prepaid, to an authorized Service Facility within the applicable warranty period, provided manufacturer's examination discloses to its satisfaction that the product was defective. The manufacturer may, at its option, replace the product in lieu of repair. With regard to any covered product returned within the applicable warranty period, repairs or replacement will be made without charge and with return freight paid by the manufacturer, unless the failure was caused by misuse, neglect, accident, or abnormal conditions of operation or storage, in which case repairs will be billed at a reasonable cost. In such a case, an estimate will be submitted before work is started, if requested.

THE FOREGOING WARRANTY IS IN LIEU OF ALL OTHER WARRANTIES, EXPRESSED OR IMPLIED, INCLUDING BUT NOT LIMITED TO ANY IMPLIED WARRANTY OF MERCHANTABILITY, FITNESS, OR ADEQUACY FOR ANY PARTICULAR PURPOSE OR USE. THE MANUFACTURER SHALL NOT BE LIABLE FOR ANY SPECIAL, INCIDENTAL OR CONSEQUENTIAL DAMAGES, WHETHER IN CONTRACT, TORT, OR OTHERWISE.

TABLE OF CONTENTS

1 SAFETY INSTRUCTIONS	1
2 DESCRIPTION	4
3 GP MONITOR	5
3.1 TECHNICAL DATA	5
3.1.1 <i>Measurement Specifications</i>	5
3.1.2 <i>Electrical Specifications</i>	6
3.1.3 <i>Environmental Specifications</i>	6
3.2 MOUNTING INSTRUCTIONS	7
3.2.1 <i>Mounting Bracket Accessory</i>	8
3.2.2 <i>Cutout Template and Cosmetic Frame</i>	10
3.3 ELECTRICAL INSTALLATION	11
3.3.1 <i>Terminal Block Layout</i>	11
3.3.2 <i>Raytek Sensor Model GP</i>	12
3.3.3 <i>Raytek Sensor Model XR</i>	12
3.3.4 <i>Raytek Sensor Models CI3, CM, TX</i>	12
3.3.5 <i>Common Input Devices</i>	13
3.3.6 <i>Power Connections</i>	15
3.3.7 <i>Output Connections</i>	16
3.3.8 <i>External Relay (Accessory)</i>	17
3.4 OPERATION.....	17
3.4.1 <i>Control Panel</i>	17
3.4.2 <i>Device Selection</i>	19
3.4.3 <i>Emissivity</i>	21

3.4.4	<i>Setpoints 1 and 2</i>	22
3.4.5	<i>Analog 4 - 20 mA Output</i>	26
3.4.6	<i>Degrees C and F</i>	27
3.4.7	<i>Signal Processing</i>	28
3.4.8	<i>Ambient Temperature Compensation</i>	29
3.4.9	<i>Display and Analog Output Offset</i>	30
3.4.10	<i>Thermocouple Output</i>	31
3.4.11	<i>Lockout Mode</i>	32
3.4.12	<i>Factory Defaults</i>	33
3.5	QUICK REFERENCE	33
4	INSTALLATION OF SENSING HEADS	38
4.1	RAYTEK SENSING HEADS	38
4.9	AIMING THE SENSING HEAD	42
5	GPR/GPS SENSING HEAD	43
5.1	OPTIONS	46
5.1.1	<i>Air/Water-cooled Housing (GPR/GPS)</i>	46
5.2	ZUBEHÖR	48
5.2.1	<i>Adjustable Mounting Bracket</i>	48
5.2.2	<i>Air Purge Collar</i>	48
5.2.3	<i>Right Angle Mirror</i>	50
5.2.4	<i>Sighting Viewer (GPR)</i>	51
5.3	TECHNICAL DATA	51
5.3.1	<i>Optical Parameter</i>	51
5.3.2	<i>Measurement Specifications</i>	54
5.3.3	<i>Environmental Specifications</i>	54

6 MAINTENANCE	56
6.1 FAIL-SAFE OPERATION	57
6.2 CLEANING THE LENS	57
7 APPENDIX	59
7.1 DETERMINATION OF EMISSIVITY	59
7.2 TYPICAL EMISSIVITY VALUES	60
8 NOTES	64

1 Safety Instructions

This document contains important information, which should be kept at all times with the instrument during its operational life. Other users of this instrument should be given these instructions with the instrument. Eventual updates to this information must be added to the original document. The instrument should only be operated by trained personnel in accordance with these instructions and local safety regulations.

Acceptable Operation

This instrument is intended only for the measurement of temperature. The instrument is appropriate for continuous use. The instrument operates reliably in demanding conditions, such as in high environmental temperatures, as long as the documented technical specifications for all instrument components are adhered to. Compliance with the operating instructions is necessary to ensure the expected results.

Unacceptable Operation

The instrument should not be used for medical diagnosis.

Replacement Parts and Accessories

Use only original parts and accessories approved by the manufacturer. The use of other products can compromise the operational safety and functionality of the instrument.

Instrument Disposal



Disposal of old instruments should be handled according to professional and environmental regulations as electronic waste.

Safety Instructions

Operating Instructions

The following symbols are used to highlight essential safety information in the operation instructions:



Helpful information regarding the optimal use of the instrument.



Warnings concerning operation to avoid instrument damage and personal injury.



The instrument can be equipped with a Class 2 laser. Class 2 lasers shine only within the visible spectrum at an intensity of 1 mW. Looking directly into the laser beam can produce a slight, temporary blinding effect, but does not result in physical injury or damage to the eyes, even when the beam is magnified by optical aids. At any rate, closing the eye lids is encouraged when eye contact is made with the laser beam. Pay attention to possible reflections of the laser beam. The laser functions only to locate and mark surface measurement targets. Do not aim the laser at people or animals.

Pay particular attention to the following safety instructions.



Use in 110 / 230 VAC electrical systems can result in electrical hazards and personal injury if not properly protected. All instrument parts supplied by electricity must be covered to prevent physical contact and other hazards at all times.

2 Description

The GP monitor consists of printed circuit boards, A/D converters, microprocessor, control switches, and power conditioners, all mounted in a 1/8 DIN panel-mount NEMA-12 (IP 54) enclosure. The GP monitor accepts inputs from any 0-5V and 4-20mA devices, which allows it to be used as a panel meter for many applications. Other settings allow the GP to act as a temperature monitor for Raytek fixed infrared sensors like GPR, GPS, CI3, CM, TX and XR and for other temperature gathering devices. The GP Monitor also accepts various types of thermocouple inputs. It provides two programmable setpoint alarm signals (open collector or relay) and one of two types of analog output: 4-20 mA output or thermocouple output. (Factory default is 4-20 mA output.)

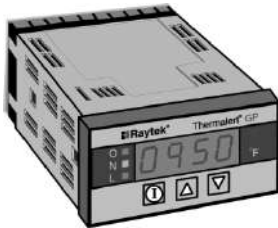

Figure 1: GP Monitor

3 GP Monitor

3.1 Technical Data

3.1.1 Measurement Specifications

Input Accuracy:	0 – 5 V input resolution: 1 mV, accuracy: ± 2 mV 4 – 20 mA input resolution: 0.01 mA accuracy: ± 0.02 mA J, K, E, N, T thermocouple input: ± 0.5 % or $\pm 2^{\circ}\text{C}$, whichever is greater R, S thermocouple input: ± 0.5 % or $\pm 3^{\circ}\text{C}$, whichever is greater
Output Accuracy:	4 – 20 mA output resolution: 0.014 mA accuracy: ± 0.02 mA J, K, E, N, T thermocouple output: ± 0.5 % or $\pm 2^{\circ}\text{C}$, whichever is greater R, S thermocouple output: ± 0.5 % or $\pm 4^{\circ}\text{C}$, whichever is greater
Response Time:	300 ms (GPR/GPS system) 200 ms (all other)
Display:	4 digit LED
Emissivity:	0.10 to 1.09, adjustable in 0.01 increments – H001 (GP heads) and H007 (XR heads) only
Warm-up Time:	5 s
Peak Hold:	0 to 998 s (999=infinite hold)
Valley Hold:	0 to 998 s (999=infinite hold)
Averaging:	0 to 60 s
Fail-Safe:	Full or low scale, depending upon system failure, see section 6.1 Fail-Safe Operation , Seite 57.

Setpoints:

Head type H001:	-18 to 538°C (0 to 1000°F)
Head type H003:	0 to 500°C (32 to 932°F)
Head type H004:	0 V input setting = low scale, 5 V input setting = high scale
Head type H005:	4 mA input setting = low scale, 20 mA input setting = high scale
Head type H006:	scale = input thermocouple range: J-type: -40 to 750°C (-40 to 1382°F) K-type: -40 to 1250°C (-40 to 2282°F) E-type: -40 to 700°C (-40 to 1292°F) N-type: -40 to 1300°C (-40 to 2372°F) R-type: 0 to 1750°C (32 to 3182°F) S-type: 0 to 1750°C (32 to 3182°F) T-type: -100 to 350°C (-148 to 662°F)
Head type H007:	-40 to 1650°C (-40 to 3002°F) (depending on model) 4 mA input setting = low scale, 20 mA input setting = high scale

3.1.2 Electrical Specifications

Voltage:	110 – 220 VAC + 20 %, 50 – 60 Hz, 100 mA
Current output:	4 to 20 mA
Max. loop impedance:	350 Ω
2 Setpoints output:	CMOS level Hi/Lo (5 V / 0 V)
GPC Monitor	SP1, SP2: 15 mA @ 5 V
Mechanical Relay:	AC contact: 250 VAC, 3 A
GPCM Monitor	DC contact: 30 VDC, 3 A

3.1.3 Environmental Specifications

Dimensions:	1/8 DIN, 118 mm length (1.75 x 3.63 x 4.75 in)
Weight:	320 g (0.7 lbs)

Rating:	IP 54 (NEMA-12), front panel only
Operating Temperature:	0 to 50°C (32 to 122°F)
Relative Humidity:	10 - 95 %, non-condensing
Storage Temperature:	-30 to 65°C (-22 to 150°F)

3.2 Mounting Instructions

The GP monitor meets NEMA-12 (IEC529, IP54) requirements (front panel only) for protection of the electronics when mounted properly. It should be surface mounted using the flanges and holes provided and mounted in such a manner to allow the free flow of air around the unit. Ambient temperatures should be kept within the range of 0 to 50°C (32 to 120°F).



Mount the monitor as far away as possible from potential sources of electromagnetic interference!

Complete the following steps to mount the GP monitor to a panel, see also Figure 2:

1. Cut a hole 45 mm high by 92 mm wide (1.8 in by 3.62 in) in the panel.
2. Slip the gasket over the rear of the monitor and then back the monitor into the hole from the front side of the panel. (Mounting bracket and cosmetic frame are available as accessories.)
3. Attach the fixing clamps to both sides of the monitor. Make sure the tab is secure in the hole on both sides.
4. Fix the monitor with the clamp screws!

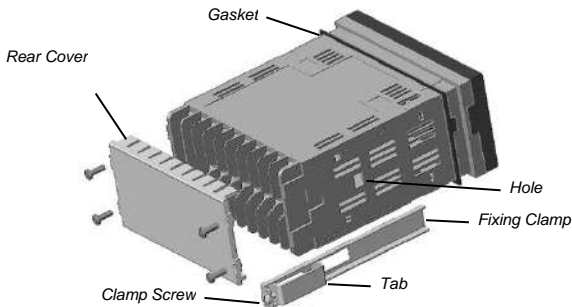

Figure 2: Mounting the Monitor

5. Secure the monitor to the panel by tightening both fixing clamp screws until the flanges are snug against the back surface of the panel.
6. Connect the terminal cable as described in the following section.
7. After you complete the electrical installation, secure the rear cover to the back of the monitor.



Do not operate with rear cover removed because of electrical shock hazard!

3.2.1 Mounting Bracket Accessory

A mounting bracket is available as an accessory. To mount a GP Monitor to a wall, post, column, or other flat surface, complete the following steps:

1. Insert the rear of the monitor through the bracket's opening so the bottom of the monitor rests on the bracket surface. Make sure the gasket is in place Figure 3.

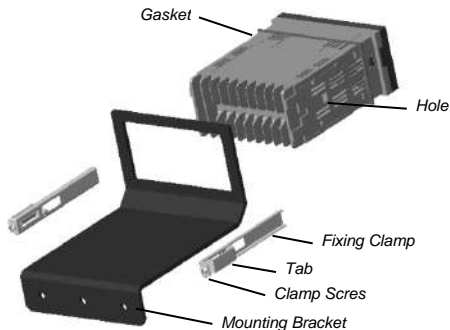

Figure 3: Mounting Bracket Accessory Installation

2. Insert the Tab on the side of each fixing clamp (one per side) into the hole on the side of the monitor housing and hold them. You might need to loosen the fixing clamp screws first, see Figure 4.

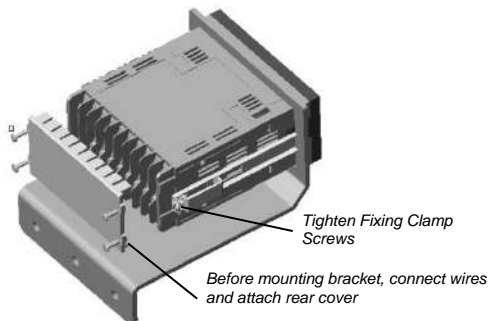

Figure 4: Completing the Installation

4. You will need to attach wires to the monitor's terminals and attach the rear cover before mounting the bracket onto a surface. (Refer to the manual for wiring instructions for your particular device.)
5. Use 3 appropriately sized screws or bolts to fasten the bracket onto your work surface.

This completes the monitor bracket accessory installation.

3.2.2 Cutout Template and Cosmetic Frame

If you are mounting your monitor into a panel, this plastic frame can be used as a template for determining the proper dimensions for your panel cutout. To use, hold or tape the template against the panel at the location where you want to mount the monitor, and mark around the inside edges, see Figure 5.

Once you cut the panel, you can use this template as a frame to hide scratches or small voids on the panel that might have been created during the cutting process.

To install, simply insert the frame between the monitor bezel and mounting gasket prior to inserting the monitor into the panel.

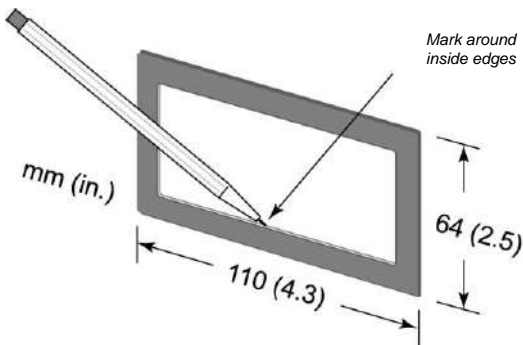

Figure 5: 1/8 DIN Cutout Template and Cosmetic Frame

3.3 Electrical Installation

3.3.1 Terminal Block Layout

Either soldered spade lugs or bare wires are acceptable for connections.

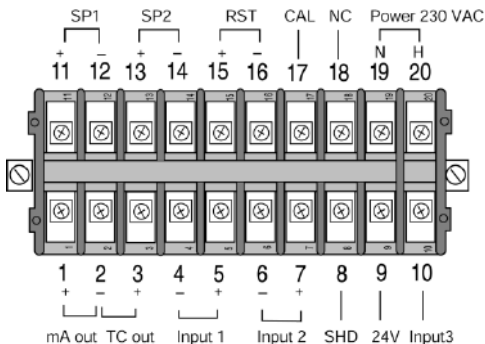

Figure 6: Terminal Block Layout

Terminal block definitions:

- | | |
|---------------------------------------|-----------------------------|
| 1 4 - 20 mA output + | 11 Setpoint 1 + / Relay 1 * |
| 2 4 - 20 mA/TC output - | 12 Setpoint 1 - / Relay 1 * |
| 3 TC output + | 13 Setpoint 2 + / Relay 2 * |
| 4 TC input - | 14 Setpoint 2 - / Relay 2 * |
| 5 TC input + | 15 Reset + |
| 6 Input 2 - (Ground) | 16 Reset - (Ground) |
| 7 Input 2 + (0-5 V or ambient signal) | 17 Calibration (Potential!) |
| 8 Shield | 18 no connection |
| 9 24 VDC output power (50 mA max) | 19 N Neutral (power) |
| 10 Input 3 (4 - 20 mA or GPR/GPS) | 20 H Hot (power) |

* see Table 8 [Output Connections](#), page 17



Incorrect wiring can damage the monitor, sensor, and/or input device and void the warranty!

3.3.2 Raytek Sensor Model GP

The following table shows wiring connections for the GP sensing heads to the monitor.

GPR/GPS (including high temperature cable)	
Terminal Pin	Wire Color
6	black
7	green
8	bare
9	red
10	white

Table 1: Wiring GP Sensing Heads

3.3.3 Raytek Sensor Model XR

The following table shows wiring connections for the XR sensing heads to the monitor.

XR	
Pin Monitor	Function
6	Ground
8	Shield
10	mA signal

Table 2: Wiring XR Sensing Heads

3.3.4 Raytek Sensor Models CI3, CM, TX

The following tables show wiring connections for the CI3, CM, TX sensing heads to the monitor.

CI3		TX	
Terminal Pin	Function / Wire Color	Terminal Pin	Function
4	Power (-) / black	8	Shield
6	Signal ground / green	9	TX (+)
7	Signal (+) / white	10	TX (-)
8	Shield		
9	Power (+) / red		

Table 3: Wiring CI3 / TX Sensing Heads

CM	
Pin Monitor	Wire Color
4	black
6	brown
7	yellow
8	shield
9	orange

Table 4: Wiring CM Sensing Heads

The GP monitor is supplying power to the CI3, CM and TX when connected as described in the table above and external power connections are unnecessary (maximum power = 24 VDC @ 50 mA). Please note that sensing heads other than those listed above may need external power if their power consumption needs exceed what is available from the monitor!

3.3.5 Common Input Devices

The following tables show the wiring for sensing heads or input devices with 0-5 V and 4-20 mA outputs or thermocouples to the monitor.

0 - 5 V		4 - 20 mA	
Pin	Function	Pin	Function
6	Signal (-)	6	GND
7	Signal (+)	8	Shield
8	Shield	10	4 - 20 mA Input

External Reset Input		Thermocouple Input	
Pin	Function	Pin	Function
15	Reset	4	Signal (-)
16	GND	5	Signal (+)

Table 5: Wiring Sensing Heads or Input Devices

The External Reset Input is used to restart the “clock” for the PeakHold/ ValleyHold/Averaging functions but not to reset the values to 0. The reset can be activated by installing a switch between terminals 15 and 16.

Use Table 6 when connecting either 0-5 V or 4-20 mA input devices that can use the 24 VDC/50 mA power available from the monitor.

Make sure to unplug the unit before wiring devices or power!

0 - 5 V		4 - 20 mA 4 Wire		4 - 20 mA 2 Wire	
Pin	Function	Pin	Function	Pin	Function
6	Power (-)	6	Power (-)	8	Shield
6	Signal (-)	6	4 - 20 mA (-)	9	4 - 20 mA (+)
7	Signal (+)	8	Shield	10	4 - 20 mA (-)
8	Shield	9	Power (+)		
9	Power (+)	10	4 - 20 mA (+)		

Table 6: Wiring Devices that Use Power from Monitor

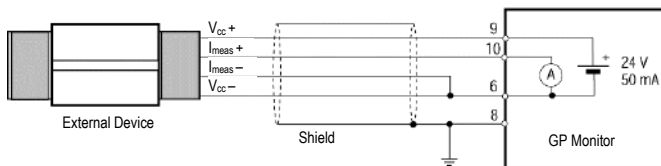

Figure 7: Installation 4 – 20 mA (4 Wires)

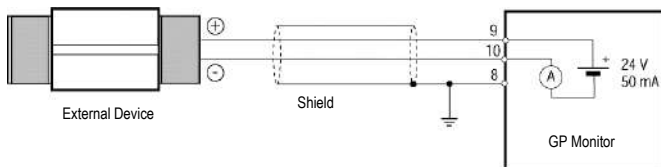

Figure 8: Installation 4 – 20 mA (2 Wires)

For further information see section 3.4.2 [Device Selection](#), Seite 19.

3.3.6 Power Connections

You can connect 110-220VAC, 50-60Hz, to the monitor. It can automatically sense whether you connect 110 or 220 VAC. Use Table 7 as a guide.

Pin	Funktion
18	Erde (Netz)
19	N Nulleiter
20	H Phase

Table 7: Power Connections



The unit be used in a closed cabinet to prevent electrical shock!

3.3.7 Output Connections

The monitor has the following outputs:

- 4 - 20 mA
- Thermocouple outputs (J, K, E, N, T, R, and S)
- Setpoints 1 und 2, optional: potential free relay contacts

4 - 20 mA

Pin	Function
1	4-20 mA output
2	Analog ground
8	Shield

Thermocouple

Pin	Function
2	Thermocouple (-)
3	Thermocouple (+)

GPC: Setpoints 1 and 2		GPCM: Relay (optional)	
Pin	Function	Pin	Function
11	Setpoint 1 ($R_{Last} > 100 \Omega$)	11	Opener 1 / Closer 1
12	Digital ground	12	Changer 1
13	Setpoint 2 ($R_{Last} > 100 \Omega$)	13	Opener 2 / Closer 2
14	Digital ground	14	Changer 2

Table 8: Output Connections

3.3.8 External Relay (Accessory)

A solid state relay accessory is available as a switching output for setpoint use as a control for an alarm or triggering mechanism. The setpoint output can supply 15 mA @ 5 V for SSR control. A wiring diagram for the relay accessory is shown in the following figure. Two relays are necessary to take advantage of both setpoints.

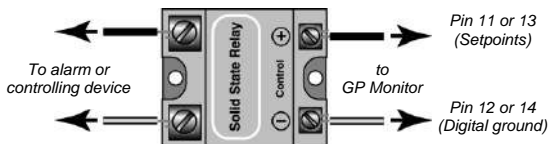

Figure 9: Relay Accessory Wiring

The following relay is available:

- DC activated / electrically isolated solid state relay for AC voltages from 24 – 330 VAC / 10 A (XXXGPSSRAC)

3.4 Operation

3.4.1 Control Panel

The GP Monitor consists of a control panel with 4 LED's, 3 buttons, and 5 indicating lights. Besides displaying the current temperature or user-defined value, the LED's also display parameter settings. By

using the **I** key and the **▲** and **▼** arrow keys you can control the different functions, and the indicator LED's show the function being addressed. The following figure shows the start-up screen when power is first turned on (no information stored on EEPROM), or when factory defaults are restored, see section 3.4.12 [Factory Defaults](#), Seite 33.

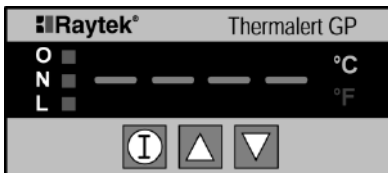

Figure 10: The Control Panel Start-up Screen

The “N” indicator, on the left side of the panel, when lit, shows that the unit is working normally. The “O” and “L” indicators are controlled by Setpoints 1 and 2 (SP1, SP2). The “O” indicator, when lit, shows that the measured temperature or value exceeds the current SP1 or SP2 setting. The “L” indicator, when lit, indicates that the measured temperature or value is lower than the current SP1 or SP2 setting.

On the right side of the panel are two indicators that show which temperature value the unit is set to if temperature sensors are attached to the monitor. The “C” indicates if the temperature measurement is in degrees C (Celsius). The “F” indicates if the temperature measurement is in degrees F (Fahrenheit). For 0-5 volt and 4-20 mA devices that do not measure temperatures, C and F can both be turned off.

Before turning on the power, make sure all wiring connections are secure. Note that all controls can be adjusted while the power is on without damaging sensor or electronics, see sections [3.4.2](#) to [3.4.12](#).

3.4.2 Device Selection

Several device types can be connected to the electronics enclosure. Complete the following procedure to set the electronics to the appropriate device.

From the temperature/value display, press and hold \blacktriangle , press \square , then release them both. A display similar to the following figure appears.

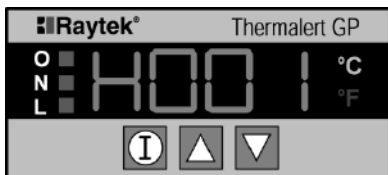

Figure 11: Device Selection Display

The “H” will be followed by numbers designating the device type. Press the \blacktriangle and \blacktriangledown buttons to change the number on the display to the appropriate head type.

Head types are as follows:

H001 = Raytek GPR Standard Head

H001 = Raytek GPS Head with laser sighting

H003 = Raytek CI3 Head

H004 = Raytek CM Head, 0 – 5 V input

H005 = 4 – 20 mA input, e.g. Raytek TX Head

H006 = Thermocouple input

H007 = 4 – 20 mA input, e.g. Raytek XR Head with emissivity setting

Note that all head types except H003 have additional display settings.

H001

If H001 is displayed, press the button \square once to be able to turn the decimal Off (“0”) or On (“1”). A “d” is displayed on the monitor. When

the decimal is On, it will be positioned at a tenth of a degree (for example, 888.8). Press the button  again to return to the temperature display.

H003





The sensor attached as H003 has a fixed emissivity and no additional monitor adjustments are necessary.

H004/H005/H007





If H004, H005, or H007 are displayed, press the  button once to turn the decimal Off or to set the location of the decimal on the display. Use the following as a guide:

- d = 0 Decimal turned off
- d = 1 Decimal located at ones position (for example 8888.)
- d = 2 Decimal located at tens position (for example 888.8)
- d = 3 Decimal located at hundreds position (for example 88.88)
- d = 4 Decimal located at thousands position (for example 8.888)



Both H004 and H005 have additional settings as follows:

For H004, press the  button again to be able to adjust the 0 V equivalent temperature value (using the  and  arrows). Press  once more to adjust the 5 V equivalent temperature value.

H005/H007

For H005/H007, press the  button again to be able to adjust the 4 mA equivalent temperature value (using the  and  arrows). Press  once more to adjust the 20 mA equivalent temperature value.

H006

For H006, press the  button once to be able to turn the decimal Off ("0") or On ("1"). A "d" is displayed on the monitor. When the decimal is On, it will be positioned at a tenth of a degree (e.g., 888.8). Press the  button again to be able to select the thermocouple input type. Use the following as a guide:

- TC1 = J-type thermocouple input

- TC2 = K-type thermocouple input
- TC3 = E-type thermocouple input
- TC4 = N-type thermocouple input
- TC5 = R-type thermocouple input
- TC6 = S-type thermocouple input
- TC7 = T-type thermocouple input

Press the  button until the temperature or user-defined value displays.

H007

H007 is specific for the XR Sensor. The H007 sensor head code has the following features:

- 4-20 mA sensor signal input (like the TX, H003)
- Set point 2 output is changed from a TTL alarm output to a 0 – 5 V output which is proportional to the emissivity setting displayed on the GP monitor.

The monitor displays the temperature value based off the 4-20 mA output of the XR. The 0 – 5 V output of the GPC controls the emissivity setting of the XR.

3.4.3 Emissivity

Emissivity is a function of infrared sensors and how they measure temperatures of different materials and surfaces.

Emissivities for H001 can be adjusted from 0.10 to 1.09 (adjustable in 0.01 increments). Note that you cannot change emissivity for device type H003 (fixed at 0.95) or for H004, H005 and H006, because emissivity adjustments are not available through the GP monitor for these device types and thermocouples. For H001, complete the following procedure to set emissivity.

1. In temperature mode display, press the  button until a display similar to following figure appears. The “E” will be followed by numbers designating the emissivity.

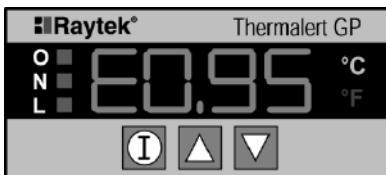





Figure 12: Emissivity Display

2. Press the  and  buttons to change the number on the display to the appropriate emissivity.
3. Press the  button until the temperature displays.

3.4.4 Setpoints 1 and 2

Setpoints are preset at the factory for the highest measurement value but are deactivated by default. To adjust setpoints, complete the following:

1. In temperature/value display, press the  button until a display similar to the following figure appears. Setpoint 1 shows as “S1” followed by a number 0, showing that Setpoint 1 is Inactive, or a number 1, designating active.

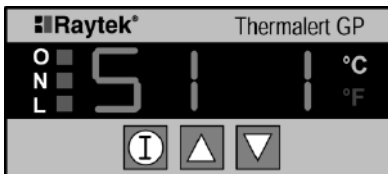







Figure 13: Setpoint Display (Showing Setpoint 1 Active)

2. When either S1 or S2 is displayed, press the  or  buttons to activate or deactivate the setpoint (a number “1” displays when the setpoint is active, a number “0” displays when it’s inactive).

3. Press the  button, and the display shows the current alarm temperature or value (Setpoint value). Use the  and  arrows to adjust the alarm value.
4. Press the  button again and a display similar to the following figure appears. If you see a number “1,” it means the Normally Low setpoint will change state when the target temperature or value exceeds the alarm value. If a number “0” displays, the Normally Low setpoint will change state when the target temperature or value is lower than the setpoint alarm value.

If you see a number “3,” it means the Normally High setpoint will change state when the target temperature or value exceeds the alarm value. If a number “2” displays, the Normally High setpoint will change state when the target temperature or value is lower than the setpoint alarm value.

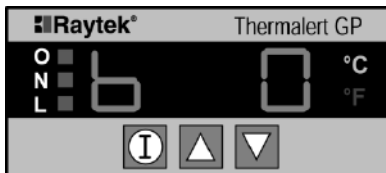
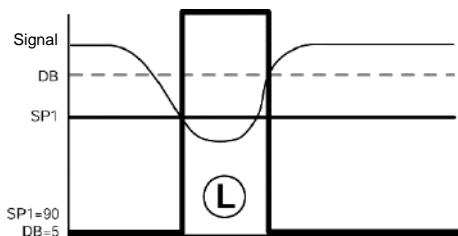

Figure 14: Setpoint Alarm (Trigger) Display

Note that the “O” and “L” indicators on the monitor are controlled by SP1 and SP2. The “L” lights when the input signal has fallen below either the SP1 or SP2 value and when the trigger level (“b”) is set to either “0” or “2”. The “O” indicator lights when the input signal has risen above either the SP1 or SP2 value and when the trigger level (“b”) is set to either “1” or “3”. The following figures shows examples of how the setpoints change state when triggered.

GP Monitor Display = b 0 Trigger signal low, output normally low



GP Monitor Display = b 1 Trigger signal high, output normally low

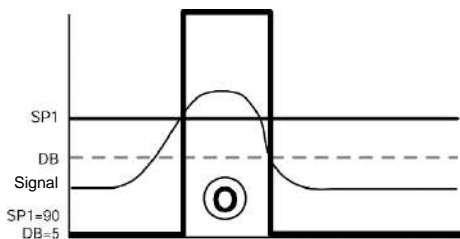

GP Monitor Display = b 2 Trigger signal low, output normally high

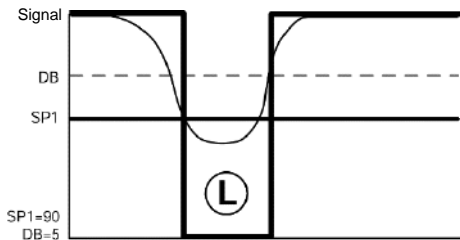

GP Monitor

The deadband is the temperature/value band (\pm) about a setpoint, wherein an alarm output or relay cannot change state.

3.4.5 Analog 4 - 20 mA Output

Note: The 4 - 20 mA analog output is disabled when the thermocouple output is active, see section 3.4.10 [Thermocouple Output](#), page 31.

Complete the following for setting a temperature to correspond to the 4-20mA analog output:

1. Press the  button until the 4 mA output display displays, see the following figure.

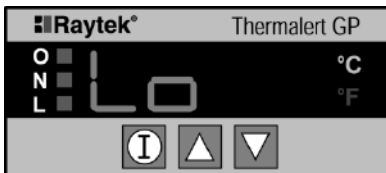





Figure 17: 4 mA Analog Output Display

2. Press the  button again, and the current 4 mA temperature displays.
3. Press the  and  buttons to adjust the temperature value.
4. Pressing the  button again brings up the 20 mA display.

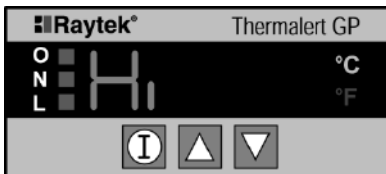

Figure 18: 20 mA Analog Output Display

- Press the ▲ and ▼ buttons to adjust the temperature value.
- Press the ⓘ button until the temperature mode is displayed.

3.4.6 Degrees C and F

You can change the temperature display unit from °C to °F, from °F to °C, or to both off by completing the following steps:

- Press the ⓘ button until a “C” shows in the display.

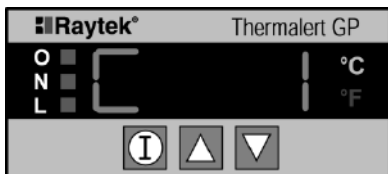

Figure 19: Degrees C Activation Display

- Pressing the ▲ and ▼ buttons activates or deactivates °C as a temperature measurement unit. If you select number “1”, °C is active; if you select number “0,” it is inactive. See the following table for setting configurations.
- Press the ⓘ button again brings up the degrees F activation display. To activate or deactivate degrees F, press the ▲ and ▼ arrows.
- Press the ⓘ button until the temperature mode is displayed.

°C	°F	Function
1	0	°C lit on monitor
0	1	°F lit on monitor
0	0	To disable °C/°F indicators (only for H004 and H005)
1	1	Not available

Table 9: The °C and °F Configurations



Thermocouple output is available for H004 and H005 only if either °C or °F is activated!



3.4.7 Signal Processing

The Peak Hold, Valley Hold, and Average times are factory set at 0 seconds and are not activated. If you don't need to use these signal processing functions, no adjustments are necessary.



Only one signal processing setting can be active at a time!

To set and activate, complete the following steps:

1. Press and hold the  button and press the  button and release them both. The Peak Hold display appears:

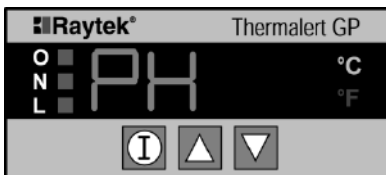





Figure 20: Peak Hold Display

2. Press the  button again and the display shows the current Peak Hold value in seconds.
3. Set the display by using the  and  buttons. Note that "000" turns off Peak Hold.
4. Press the  button again and the Valley Hold display appears.

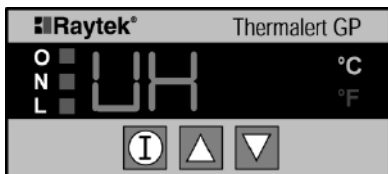





Figure 21: Valley Hold Display

5. Press the  button once more and the display shows the current Valley Hold value in seconds.
6. Set the display by using the  and  buttons. Note that “000” turns off Valley Hold.
7. Press the  button again and the Averaging display appears.

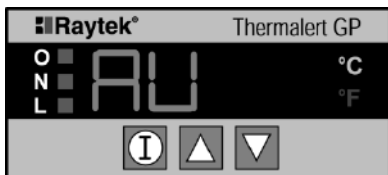





Figure 22: Averaging Display





8. Press the  button once more and the display shows the current Averaging value in seconds.
9. Set the display by using the  and  buttons. Note that “000” turns off Averaging.
10. Press the  button again until the temperature mode is displayed.

3.4.8 Ambient Temperature Compensation

Head type H001 only - The ambient temperature compensation is factory preset as inactive. This value is normal for most applications. However, in some applications the surrounding ambient temperature

is much higher than the target. If the target has an emissivity less than 1.0, it will reflect a certain portion of the surrounding energy and cause an erroneous temperature reading. To avoid this error, set in the average surrounding temperature and the microprocessor will automatically compensate for it.

To set T-Ambient, complete the following:

1. Press and hold the  button, and press the  button, then release them both. The Peak Hold display appears, see Figure 20.
2. Press the  button several times until the Ambient Compensation indicator displays, as shown in the following figure. The display shows either a "0" or "1" (default = "0" - Off).
3. You can activate or deactivate Ambient Temperature Compensation by using the  and  buttons. A number "1" means it is active; a number "0" means it is inactive.

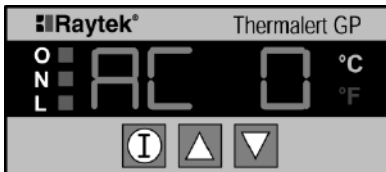









Figure 23: Ambient Temperature Compensation Display

4. To adjust the ambient temperature compensation, press the  button once more.
5. Set the value by using the  and  buttons.
6. Press the  button until the temperature/value mode displays.

3.4.9 Display and Analog Output Offset

To adjust and set the Display and Analog Output Offset (applies to displayed temperature and all analog outputs), complete the following steps:

1. Press the  button and the  button simultaneously then release. The Peak Hold display appears, see Figure 20.
2. Press the  button several times until the Offset indicator displays:

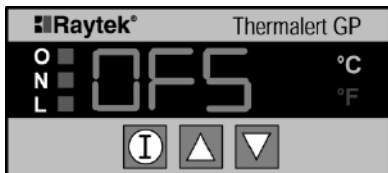









Figure 24: Offset Indicator Display

3. To adjust the display and output offset, press the  button once more.
4. Set the display by using the  and  buttons.
5. Press the  button until the temperature mode displays.

3.4.10 Thermocouple Output

Thermocouple output is factory preset as inactive. To adjust and set the type of thermocouple output, complete the following steps:

1. Press and hold the  button, and press the  button, then release them both. The Peak Hold display appears, see Figure 20.
2. Press the  button several times until the thermocouple output indicator displays as shown in the following figure:

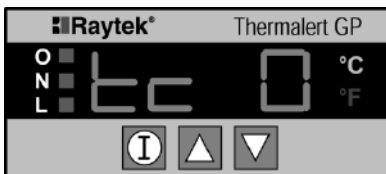

Figure 25: Thermocouple Output

3. Press the ▲ and ▼ buttons to change the number on the display to the appropriate thermocouple output type. Use the following as a guide:
 - TC1 = J-type thermocouple output
 - TC2 = K-type thermocouple output
 - TC3 = E-type thermocouple output
 - TC4 = N-type thermocouple output
 - TC5 = R-type thermocouple output
 - TC6 = S-type thermocouple output
 - TC7 = T-type thermocouple output
4. Press the **I** button until the temperature/value mode displays.

Note: Thermocouple output is available for H004 and H005 inputs only if either °C or °F is activated. The 4 - 20mA analog output is disabled when the thermocouple output is active.

3.4.11 Lockout Mode

The Lockout Mode protects you from accidental value changes or from tampering. When you activate lockout, no mode values can be changed.

To activate Lockout:

Press and hold the ▼ button, press the **I** button 3 times, then release. The letter "L" appears on the display for approximately 3 seconds showing that Lockout has been activated.

To deactivate Lockout:

1. Press the **[i]** button once to get the emissivity adjustment display.
2. Press the **[v]** button, the **[i]** button 3 times, then release. The letter “E” displays for approximately 3 seconds showing that Lockout has been deactivated.
3. Press the **[i]** button until the temperature mode displays.

3.4.12 Factory Defaults

If you need to reset the GP monitor to its factory default settings, you can do so by pressing and holding the **[▲]** button and then pressing the **[v]** button 3 times.

Parameter	Value	Setting Range	Remarks
Emissivity	0.95	0.1 - 1.09	For 0 - 5 V, 4 - 20 mA and thermocouple inputs, emissivity is not functional
Sensing Head/Device type	H001	H001 - H007	
Display Resolution	0	0 - 4	
Setpoints (SP1, SP2)	off	According to Sensing Head/Device type	see section 3.4.4, page 22
Peak hold	0	0-998 s (999 s = ∞)	∞: reset by hardware
Valley hold	0	0-998 s (999 s = ∞)	∞: reset by hardware
Averaging	0	0 – 60 s	
Ambient Temperature Compensation (t-amb)	0	-18 to 1200°C (0 to 2200°F)	
Offset	0	-50 to 50°C (-99 to 99°F)	

Table 10: Factory-set Default Values

3.5 Quick Reference

On the following pages are quick reference charts for setting up the GP Monitor with sensing head and input devices and for adjusting the monitor's normal and advanced functions.



Make sure the device attached to the monitor is wired correctly or damage to the monitor and attached units could occur!

Refer to the appropriate Sensing Head and Input Device wiring information in section 3.3 [Electrical Installation](#), Seite 11 before continuing.

For a detailed explanation of each function, refer to section 3.4 [Operation](#), Seite 17.

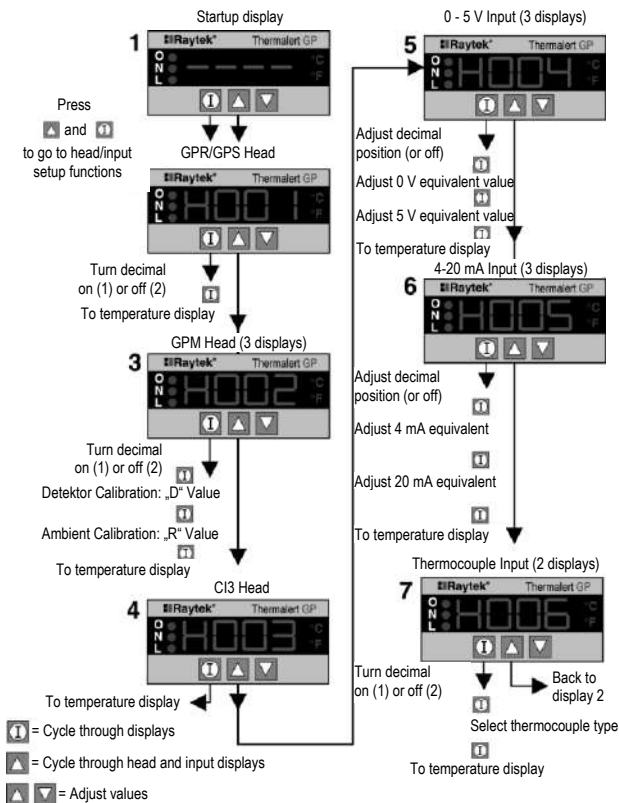

Figure 26: Head and Input Setup

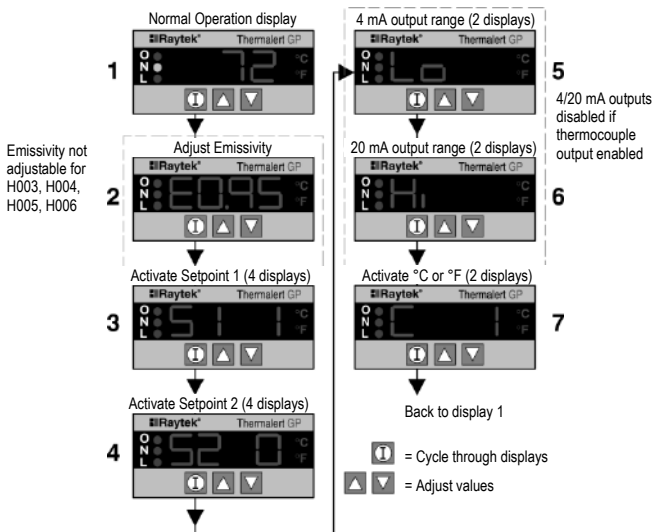

Figure 27: Normal Functions

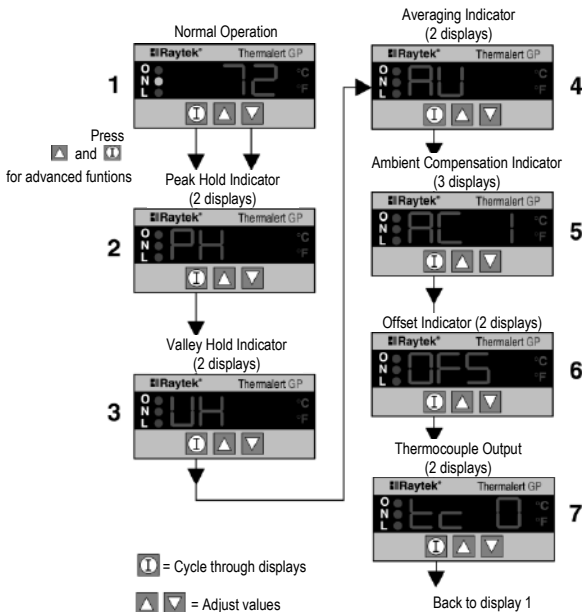

Figure 28: Advanced Functions

4 Installation of Sensing Heads

4.1 Raytek Sensing Heads

This section describes how to connect Raytek infrared sensing heads to the GP monitor. Raytek sensing heads include:

- GPR sensing head (head type H001)
- GPS sensing head with laser (head type H001)
- CI3 sensor (head type H003)
- TX/SX sensor using 4 - 20 mA connection (head type H005)
- XR sensor using 4 - 20 mA connection (head type H007)

Model	Temperature range	Optical Resolution
GPR (SF)	-18 to 538°C (-0 to 1000°F)	35 : 1
GPR (CF)	-18 to 538°C (-0 to 1000°F)	30 : 1
GPS (SF)	-18 to 538°C (-0 to 1000°F)	50 : 1
GPS (CF)	-18 to 538°C (-0 to 1000°F)	45 : 1

SF = Standard Focus, CF = Close Focus

Table 11: GP Sensing Heads

For further information for setting up the sensing heads see section 3.4.2 [Device Selection](#), page 19.

4.2 Preparation

Sensor location depends on the application. Before deciding on a location, you need to be aware of the ambient temperature of the location, the atmospheric quality of the location, and the possible electromagnetic interference in that location. If you plan to use air purging, you need to have an air connection available. Wiring and conduit runs must be considered

4.3 Ambient Temperature

The **GP Monitor** is designed for measurements in ambient temperatures between 0 to 50°C (32 to 122°F). Operation of these units outside of specified ambient temperatures is not recommended, and accuracy cannot be guaranteed.

The **GPR/GPS sensing heads** operate in ambient temperatures of 0 to 65°C (32 to 150°F). (Laser operates from 0 to 50°C (32 to 122°F).) In ambient conditions above 65°C (150°F), an optional air/water-cooled housing is available, which extends the ambient operating range to 120°C (250°F) with air cooling or 177°C (350°F) with water cooling.

4.4 Distance to Object

The desired spot size on the target will determine the maximum measurement distance and the necessary focus length of the optical module. To avoid erroneous readings the target spot size must contain the entire field of view of the sensor. Consequently, the sensor must be positioned so the field of view is the same as or smaller than the desired target size.

Installation of Sensing Heads

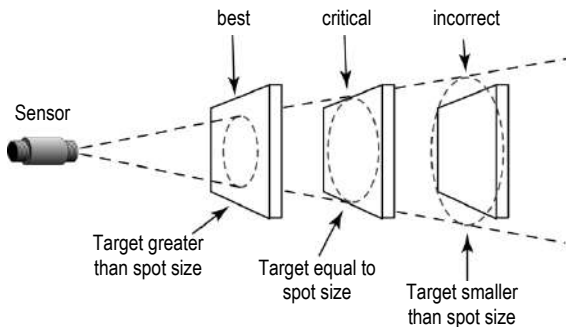

Figure 29: Proper Sensor Placement

4.5 Atmospheric Quality

It is important to keep the lens clean at all times. A clean lens can prevent erroneous readings and possible lens damage. An Air Purge Collar is available, and recommended, for all models to protect the lens from smoke, fumes, dust, and other contaminants.

4.6 Electrical Interference

To minimize electrical or electromagnetic interference or “noise,” be aware of the following:

- Mount the sensor as far away as possible from potential sources of electrical interference such as motorized equipment producing large step load changes.
- With a GP sensing head, use solid or flexible conduit between the head and electronics box. Check continuity to ensure a good connection of the conduit between the sensor head and electronics box. For a good connection, the ends of the conduit should make metal to metal contact with the sensor head and the electronics box.
- Use shielded wire for all input and output connections. Connect the shield as described in the sensing head tables in sections 3.3.2 and 3.3.3 page 12 ff. Make sure the shield wire in the sensor cable is earth grounded.
- For additional protection, use conduit for the AC power lines and any external connections. Solid conduit is better than flexible conduit in high noise environments.
- Do not run AC power for other equipment in the same conduit.

4.7 Mechanical Installation

4.7.1 GPR/GPS Sensing Head

After you complete preparations, fasten the supplied mounting bracket, or other mounting device, to the area you have chosen. You can fasten the sensor with the supplied nut either in the front, by the lens, or in the back by the cable connector. Make sure the nut is tight, but do not over tighten.

For the **GPR**, the standard 4 m (13ft) cable is an accessory and comes with a 5-pin DIN connector on one end and bare wires on the other. Plug the DIN connector into the sensing head, and run the wire to the

Installation of Sensing Heads

monitor's connectors. The GPS head uses a 7-pin DIN connector. Be sure to allow space for mounting the GPS laser switch box.

If you are using a conduit adapter and conduit for the wiring, install the conduit adapter on the sensor end of the conduit, then run the wire through it. You might need to position and tighten the mounting bracket in place after attaching the DIN connector to the sensing head and screwing the sensing head into the conduit adapter. Note that a mounting bracket may not be necessary if using rigid conduit.

4.8 Electrical Installation

For proper operation, make sure all wiring is installed correctly and the connections are tight. If strain relief is required, use standard conduit fittings. For proper operation, this cable must be free of splices and connected to the monitor's terminals exactly as indicated below.

For more information on how to wire the sensor you can find in section 3.3 [Electrical Installation](#), page 11.

4.9 Aiming the Sensing Head

All sensing heads that can be attached to the GP monitor are aimed using the same technique, which is to peak the sensor to its maximum signal. (The GPS has laser aiming.) To do this, all connections must be secure and power applied to the monitor. If a temperature does not display, press the  button until it does.

To aim the sensor, complete the following:

1. Slightly loosen the mounting bracket's nuts.
2. Point the sensor toward the target.
3. Move it around until the target's temperature displays on the monitor.
4. Secure the mounting bracket.

5 GPR/GPS Sensing Head

5.1 GPR Head

The GPR is available in Standard Focus and Close Focus models.

The sensor is supplied with a fixed bracket and mounting nut. It can also be mounted using a customer-supplied bracket or pipe adapter or other accessories.

Use the following measurements when determining space requirements for installation.

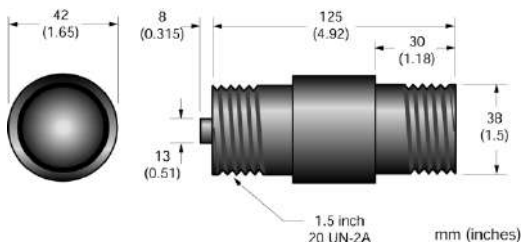

Figure 30: Dimensions for the GPR Head

Note:

All sensors and accessories are supplied with 3.8 cm (1.5") 20 UN machine threads and must not be used with standard pipe fittings. A pipe adapter is available for this purpose, if required. Make sure the inner diameter of any pipe or tube extension is not so small that it interferes with the optical field of view of the sensing head model being used.

5.2 GPS Laser Sighting Head

The laser sighting head allows fast and precise aiming at small and quick moving targets. The laser is specially aligned with the lens to provide accurate, non-parallax pinpointing of targets. Press the on/off switch at the laser switching box, and a small, bright red laser beam shows you the target center. **The laser dot indicates the center of the target, not the size of the spot being measured.** (To determine spot size, refer optical charts in section 5.3.1 [Optical Parameter](#), page 51.)

The laser is Class 2 with an output power less than 1 mW and an output wavelength of 630-670 nm. The laser has an operating range up to 30 m (100 ft), depending on ambient light level. The laser complies with FDA Radiation Performance Standards, 21 CFR, subchapter J, and meets IEC 825, Class 2 specifications.

Note: The laser automatically turns off after approximately 10 minutes of use.

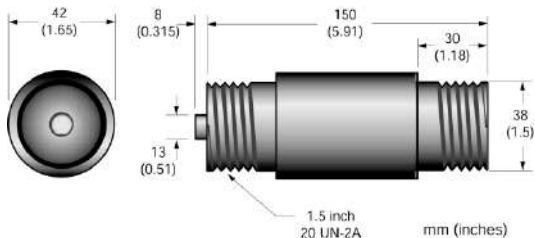

Figure 31: Dimensions for the GPS Head

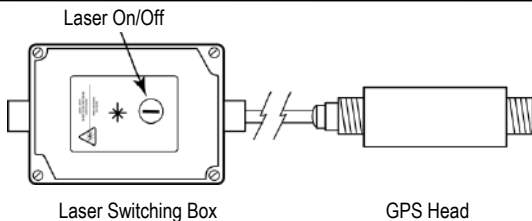

Figure 32: GPS Head and Laser Switching Box

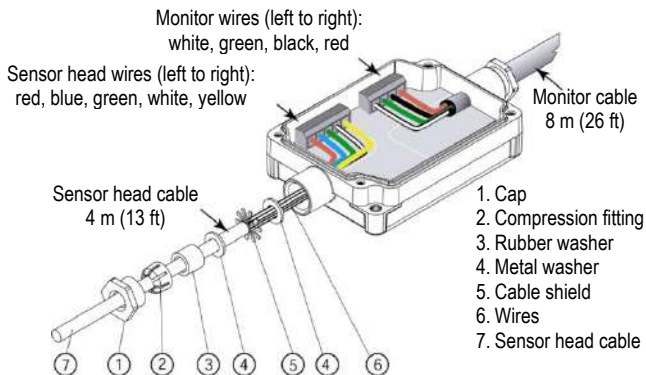

Figure 33: Laser Switching Box

WARNING!

Avoid exposure to laser light. Eye damage can result. Use extreme caution when operating. Never point at a person. Be aware of reflections!



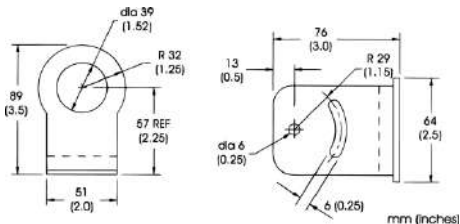

Figure 34: Fixed Mounting Bracket

5.1 Options

Options are those items that are factory installed and must be ordered with base model units

- ISO Calibration Certificate, based on NIST/DKD certified probes (GPR: XXXGPCERT, GPS: XXXGPSCERT)
- Air/water-cooled housing (...W)

5.1.1 Air/Water-cooled Housing (GPR/GPS)

The air/water-cooled housing option allows the sensor to be used in ambient temperatures up to 120°C (250°F) for air-cooled and 177°C (350°F) for water-cooled. It is supplied with two 1/8" NPT brass fittings. Air flow should be 25°C (77°F) at 2.8 liters/sec (0.74 gallon/sec) with a pressure drop across the housing of 0.63 kg/cm² (9 PSI). Water flow should be approximately 2 liters (0.5 gallons) per minute. Water temperature should be 10-27°C (50-80°F) for efficient cooling. Using chilled water below 10°C (50°F) is not recommended. To avoid condensation, it is recommended to use the Air Purge Collar with the Water Cooled Housing.

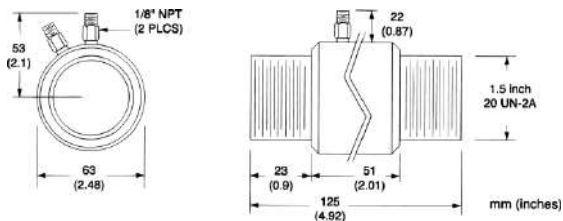

Figure 35: GPR Head with Air/Water-cooled Housing

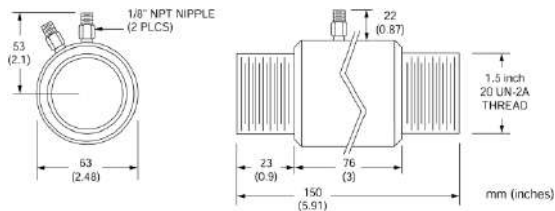

Figure 36: GPS Head with Air/Water-cooled Housing

5.2 Zubehör

Accessories include items that may be ordered at any time and added on-site:

- [Adjustable Mounting Bracket](#) (XXXTXXACAB)
- [Air Purge Collar](#) (XXXTXXACAP)
- [Right Angle Mirror](#) (XXXTXXACRA)
- [Sighting Viewer \(GPR\)](#) (XXXTXXACSV)
- Schutzrohradapter (XXXTXXACCA)
- Pipe Adapter (XXXTXXACPA)
- Fixed Mounting Bracket (included in delivery) (XXXTXXACFB)
- Mounting Nut (included in delivery) (XXXTXXACMN)
- Cable: 4 m (13 ft)
- High Temperature Cable: 8 m or 15 m (26.2 ft or 49.2 ft)

5.2.1 Adjustable Mounting Bracket

An adjustable mounting bracket is available if you require a sensor that can be aimed at different targets from the same mounted position.

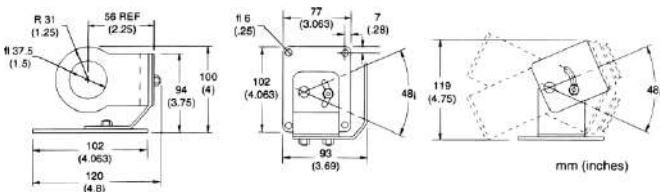

Figure 37: Adjustable Mounting Bracket

5.2.2 Air Purge Collar

The Air Purge Collar is used to keep dust, moisture, airborne particles, and vapors away from the lens. It can be installed before or after the mounting bracket. It must be screwed in fully. Air flows into the 1/8"

NPT brass fitting and out the front aperture. Air flow should be a maximum of 0.5-1.5 l/s (1-3 cfm). Clean or “instrument” air is recommended to avoid contaminants from settling on the lens.

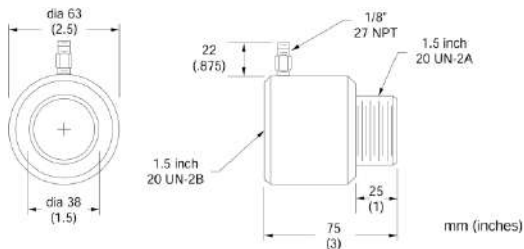

Figure 38: Air Purge Collar

5.2.3 Right Angle Mirror

The Right Angle Mirror is used to obtain a perpendicular view of the object. It is often used when space is limited or when you need to avoid excessive radiation to the sensor. It must be installed after the bracket or after the Air Purge Collar (if used) and screwed in fully. In dusty or contaminated environments, air purging is required to keep the first surface mirror clean. If used in conjunction with the Air Purge Collar, both the Right Angle Mirror and the Air Purge Collar must be air purged.

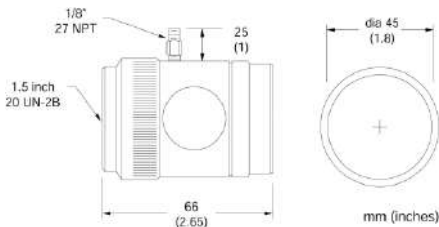

Figure 39: Right Angle Mirror

When using the Right Angle Mirror, adjust the emissivity settings downward by 5%. For example, for an object with an emissivity of 0.95 use 0.9; for an object with 0.8 use 0.76; for 0.65 use 0.62. This correction accounts for energy losses in the mirror.

5.2.4 Sighting Viewer (GPR)

The Sighting Viewer is used to aid in the alignment of the sensor. It can be used when an object is small and far from the sensor. It can also be used when direct in-line sighting is difficult. It can be used both with and without the Air Purge Collar, but not with the Right Angle Mirror. For best results, first secure the sensor to the bracket using the mounting nut or Air Purge Collar and then screw on the Sighting Viewer Tool. Next, position and secure the bracket. Be sure to remove the Sighting Viewer when alignment is complete.

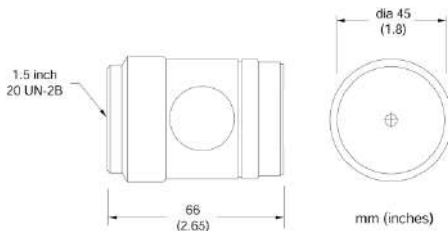

Figure 40: Sighting Viewer for GPR Head

5.3 Technical Data

5.3.1 Optical Parameter

The optical charts indicate the nominal target spot diameter at any given distance from the sensing head. Information in the top half of each diagram is in inches or feet, the bottom half is in metric units. All optical diagrams within this manual assume 90% energy.

GPR/GPS Sensing Head

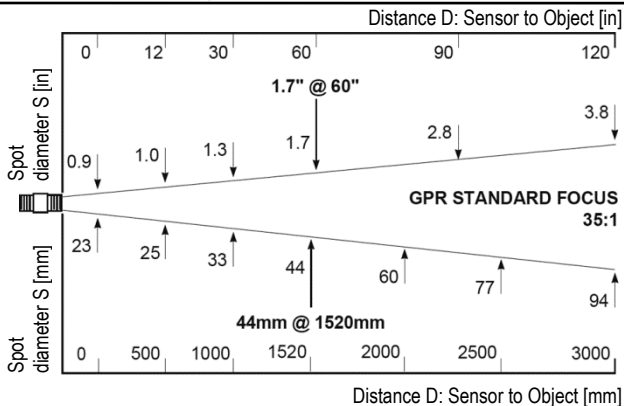

Figure 41: GPR Standard Focus Optics

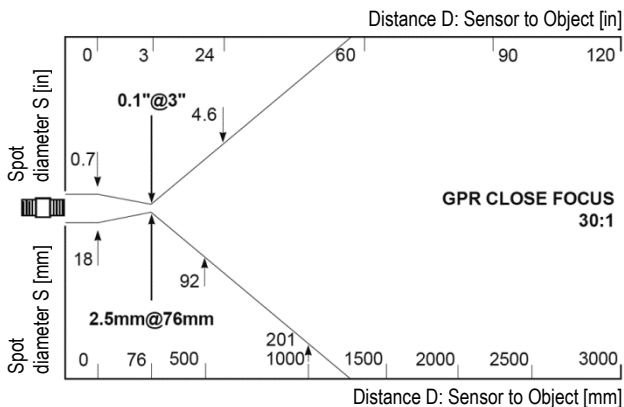

Figure 42: GPR Close Focus Optics

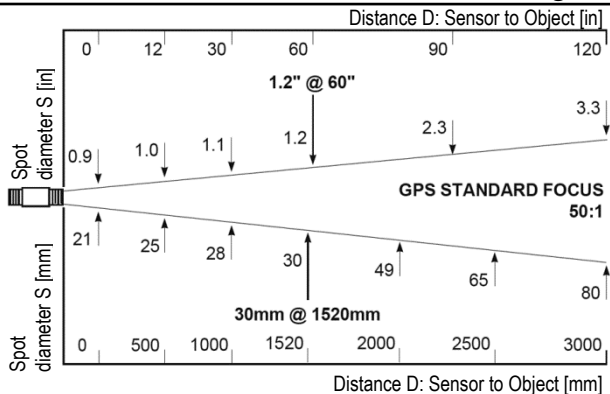

Figure 43: GPS Standard Focus Optics

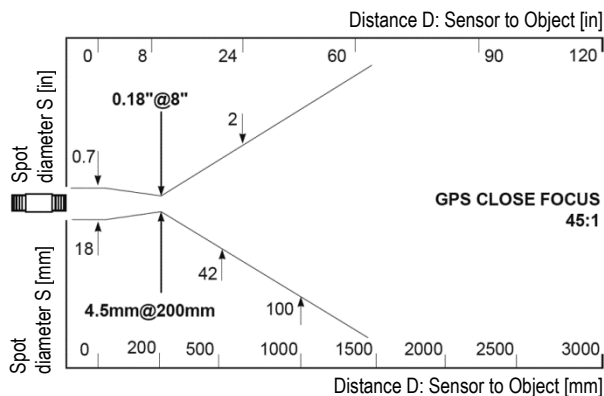

Figure 44: GPS Close Focus Optics

GPR/GPS Sensing Head

5.3.2 Measurement Specifications

Temperature range:	-18 to 538°C
Spectral response:	8 to 14 μm
Accuracy: (with GP monitor)	$\pm 1\%$ of reading or $\pm 1^\circ\text{C}$ (2°F), whichever is greater at $23^\circ\text{C} \pm 5^\circ\text{C}$ ($73 \pm 9^\circ\text{F}$) ambient
Repeatability:	$\pm 0,5\%$ of reading or $\pm 1^\circ\text{C}$ (2°F), whichever is greater at $23^\circ\text{C} \pm 5^\circ\text{C}$ ($73 \pm 9^\circ\text{F}$) ambient
Response Time:	300 ms (95% response, 4/20mA output)
Temperature Coefficient:	0.15°C per °C (0.15°F per °F)

5.3.3 Environmental Specifications

Dimensions:	see sections 5.1 and 5.2, page 43 f.
Weight:	GPR: 275 g (9.7 oz), GPS: 290 g (10 oz)
Environmental Rating:	NEMA-4 (IEC 529, IP 65) rated with conduit adapter and compression fitting (which prevents liquid from entering through the connector)
Ambient Operating:	
Head:	GPR: 0 to 65°C GPS: 0 to 65°C (laser switch off 50°C/122°F)
with air cooling:	0 to 120°C (32 to 248°F)
with water cooling:	0 to 177°C (32 to 351°F)
Storage temperature:	-30 to 65°C (-22 to 149°F)
Relative Humidity:	10-95%, non-condensing
Vibration:	MIL-STD-810D (IEC 68-2-6): 3G's, 11 to 200Hz, any axis

Mechanical Shock: MIL-STD-810D (IEC 68-2-27): 50G's, 11msec duration, any axis

6 Maintenance

Our customer service representatives are always at your disposal for questions regarding application assistance, calibration, repair, and solutions to specific problems. Our Service Department should be contacted before returning any equipment to us. In many cases, problems can be solved over the telephone. The following table lists common symptoms, their causes, and possible solutions.

Symptom	Probable Cause	Solution
No output	No power to monitor	Check power supply
Erroneous output	Wrong output range	Correct Lo/Hi output setting
Erroneous Temperature	Faulty sensor cable	Verify cable integrity
Erroneous Temperature	Field of view obstructed	Remove obstruction
Erroneous Temperature	Wrong signal processing	Correct peak/valley setting
Relays "chatter"	Deadband too narrow	Correct deadband setting

Table 12: Troubleshooting

6.1 Fail-Safe Operation

The Fail-Safe system is designed to alert the operator and provide a safe output in case of any system failure. Basically, it is designed to shutdown the process in the event of a set-up error or a failure in the sensor head or control electronics.

When an error or failure does occur, the display indicates the possible failure area, and the output circuits automatically adjust to their lowest or highest preset level, see the following table.

Display (flashing)	Condition	mA Output	Thermocouple Output
E111	Over instrument input range	20 mA	High value of input range
E000	Under instrument input range	4 mA	Low value of input range
E444	Head disconnect	4 mA	Low value of input range
E555	Head ambient temperature GPR/GPS: >65°C (150°F)	4 mA	Low value of input range
E666	Monitor ambient temperature >50°C (120°F) or <0°C (32°F)	4 mA	Low value of input range

Table 13: Fail-Safe Error Codes

Note:

With either input type H003 or H004 the under instrument input range will display low scale for the input device, and the output will be 4 mA.

6.2 Cleaning the Lens

Keep the lens clean at all times. Any foreign matter on the lens will affect measurement accuracy. However, care should be taken when cleaning the lens. To clean the lens, do the following:

- Lightly blow off loose particles.
- Gently brush off remaining particles with a soft camel hair brush.

Maintenance

- Clean remaining “dirt” using a cotton swab dampened in distilled water. Do not scratch the surface.

For finger prints or other grease, use any of the following:

- Denatured alcohol
- Ethanol
- Kodak® lens cleaner

Apply one of the above to the lens. Wipe gently with a soft, clean cloth until you see colors on the surface, then allow to air dry. Do not wipe the surface dry, this may scratch the surface.

If silicones (used in hand creams) get on the lens, gently wipe the surface with Hexane. Allow to air dry.



Do not use ammonia or cleaners with ammonia on the lens, this may result in permanent damage to the lens' surface.

7 Appendix

7.1 Determination of Emissivity

Emissivity is a measure of an object's ability to absorb and emit infrared energy. It can have a value between 0 and 1.0. For example a mirror has an emissivity of < 0.1 , while the so-called "Blackbody" reaches an emissivity value of 1.0. If a higher than actual emissivity value is set, the output will read low, provided the target temperature is above its ambient temperature. For example, if you have set 0.95 and the actual emissivity is 0.9, the temperature reading will be lower than the true temperature.

An object's emissivity can be determined by one of the following methods:

1. Determine the actual temperature of the material using an RTD (PT100), a thermocouple, or any other suitable contact temperature method. Next, measure the object's temperature and adjust emissivity setting until the correct temperature value is reached. This is the correct emissivity for the measured material.
2. For relatively low temperatures (up to 260°C / 500°F) place a plastic sticker (e.g. XXXRPMACED) on the object to be measured. This sticker should be large enough to cover the target spot. Next, measure the sticker's temperature using an emissivity setting of 0.95. Finally, measure the temperature of an adjacent area on the object and adjust the emissivity setting until the same temperature is reached. This is the correct emissivity for the measured material.
3. If possible, apply flat black paint to a portion of the surface of the object. The emissivity of the paint is 0.95. Next, measure the temperature of the painted area using an emissivity setting of 0.95. Finally, measure the temperature of an adjacent area on the object and adjust the emissivity until the same temperature is reached. This is the correct emissivity for the measured material.

7.2 Typical Emissivity Values

The following table provides a brief reference guide for determining emissivity and can be used when one of the above methods is not practical. Emissivity values shown in the table are only approximate, since several parameters may affect the emissivity of a material. These include the following:

1. Temperature
2. Angle of measurement
3. Geometry (plane, concave, convex)
4. Thickness
5. Surface quality (polished, rough, oxidized, sandblasted)
6. Spectral range of measurement
7. Transmission (e.g. thin films plastics)

Metals	Emissivity
Aluminum	
Unoxidized	0,02-0,1
Oxidized	0,2-0,4
Alloy A3003, Oxidized	0,3
Roughened	0,1-0,3
Lead	
rough	0,4
Iron	
Oxidized	0,5-0,9
Unoxidized	0,05-0,2
Rusted	0,5-0,7
Iron, Cast	
Oxidized	0,6-0,95
Unoxidized	0,2
Iron, Wrought	
dull	0,2
Copper	
Polished	0,03
Roughened	0,05-0,1
Oxidized	0,4-0,8
Haynes alloy	0,3-0,8
Inconel	
Oxidized	0,7-0,95
Sandblasted	0,3-0,6
Brass	
burnished	0,3
Oxidized	0,5
Molybdän	
Oxidized	0,2-0,6

Appendix

Metal	Emissivity
Nickel	
Oxidized	0,2-0,5
Electrolytic	0,05-0,15
Platinum	
Black	0,9
Steel	
Cold-rolled	0,7-0,9
Ground sheet	0,4-0,6
Polished sheet	0,1
Oxidized	0,7-0,9
Stainless	0,1-0,8
Titanium	
Oxidized	0,5-0,6

Table 1: Typical Emissivity Values for Metals

Non-Metal	Emissivity
Asbestos	0,95
Asphalt	0,95
Basalt	0,7
Concrete	0,95
Ice	0,98
Soil	0,9-0,98
Paint (non-al.)	0,9-0,95
Gypsum	0,8-0,95
Glass	
Plate	0,85
Rubber	0,95
Wood	0,9-0,95
Limestone	0,98
Carborundum	0,9
Ceramic	0,95
Gravel	0,95
Carbon	
Unoxidized	0,8-0,9
Graphite	0,7-0,8
Paper	0,95
Plastic (thicker than 500 µm)	0,95
Cloth	0,95
Sand	0,9
Snow	0,9
Clay	0,95
Water	0,93

Table 2: Typical Emissivity Values for Non-Metals

8 Notes